

ClientProtector™ Control Flow-Charts

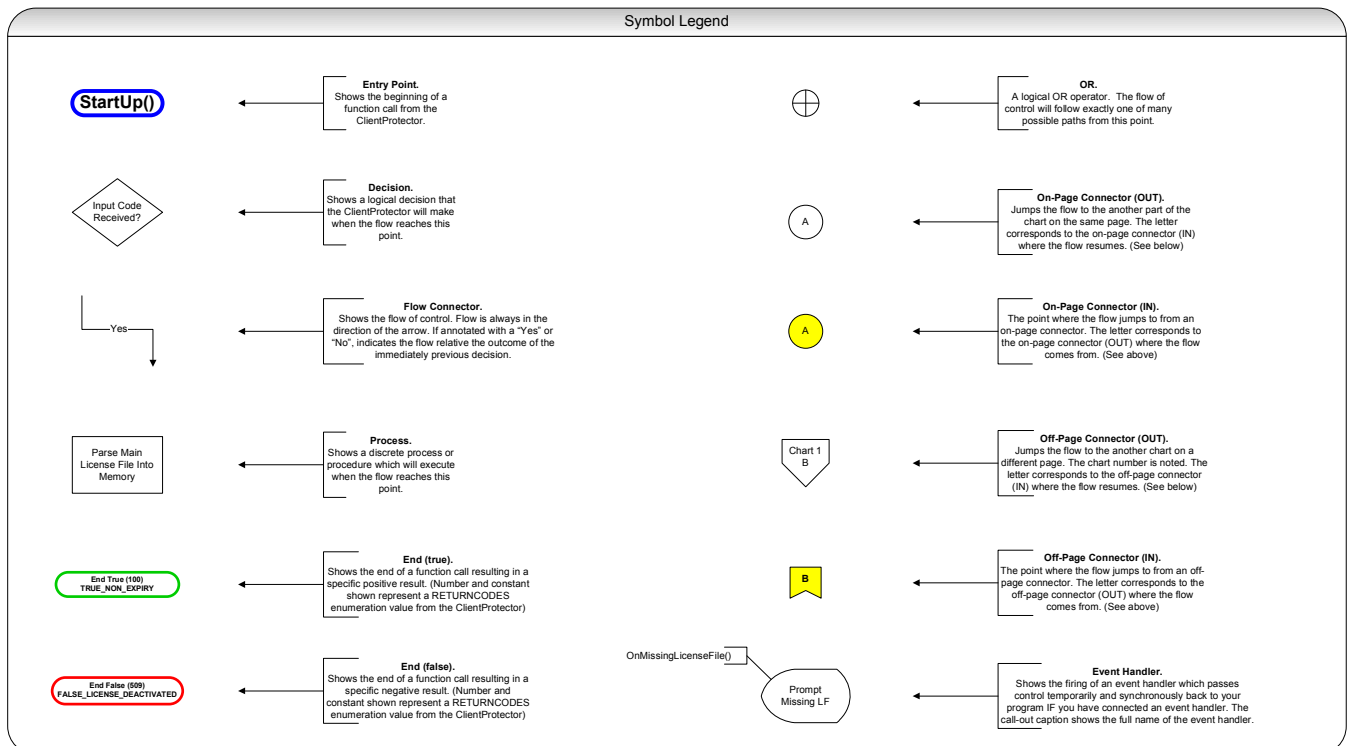

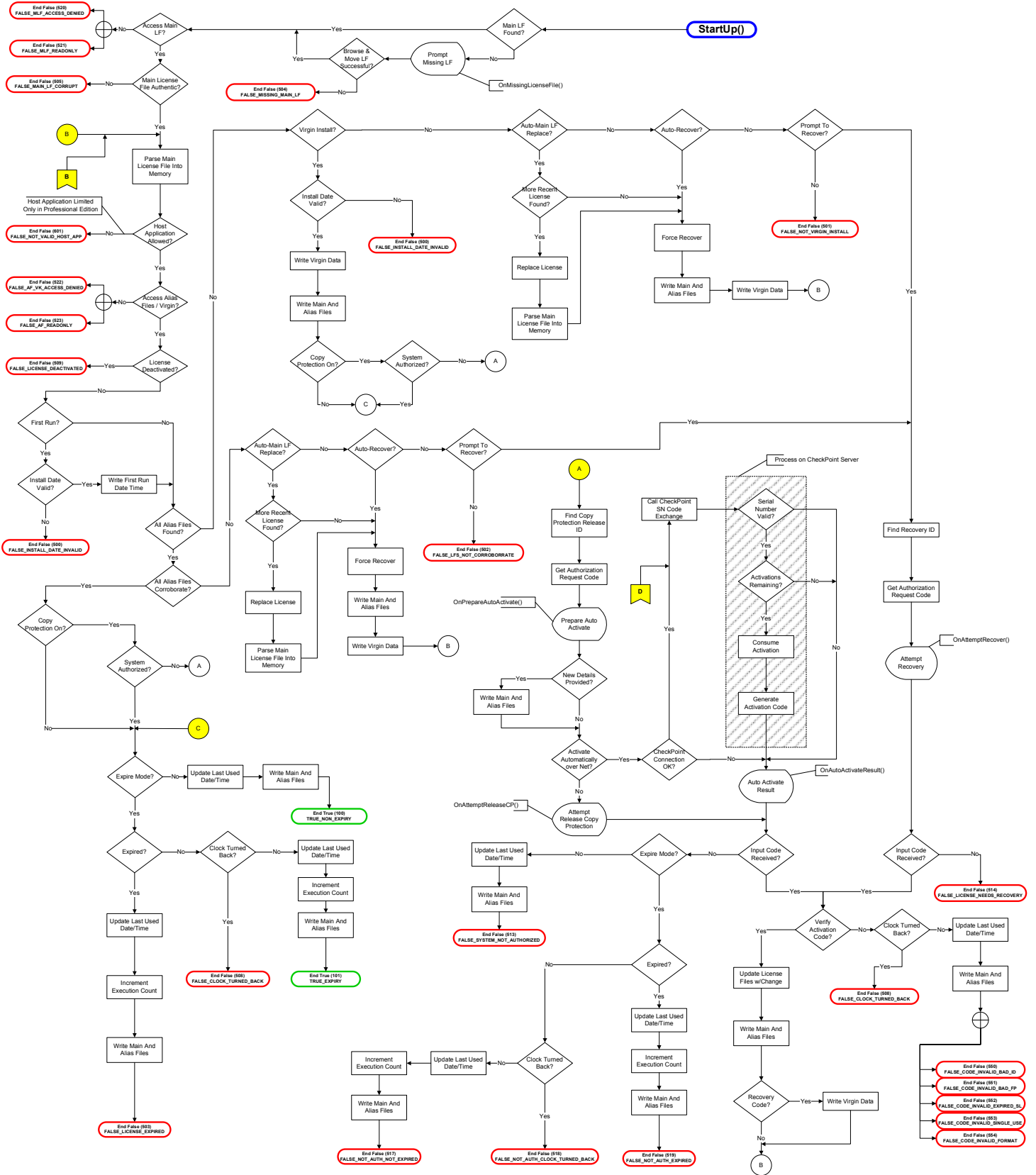

RequestDeactivation()

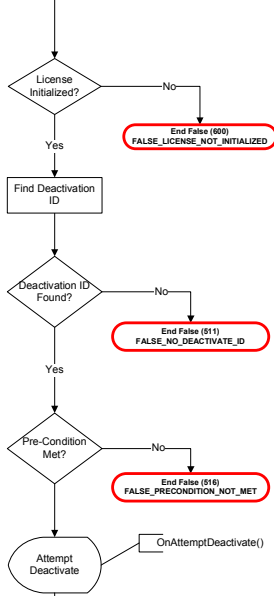

InputActivationCode()

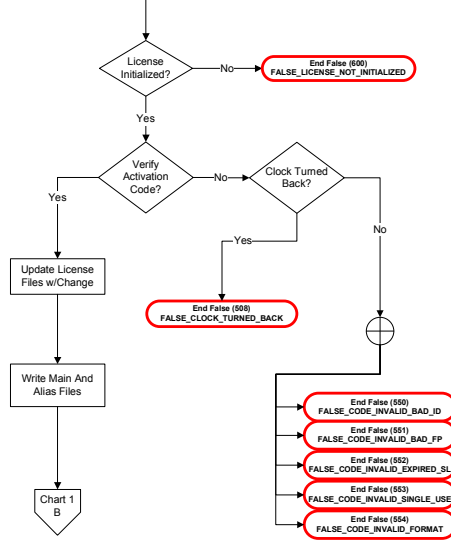

RequestActivation()

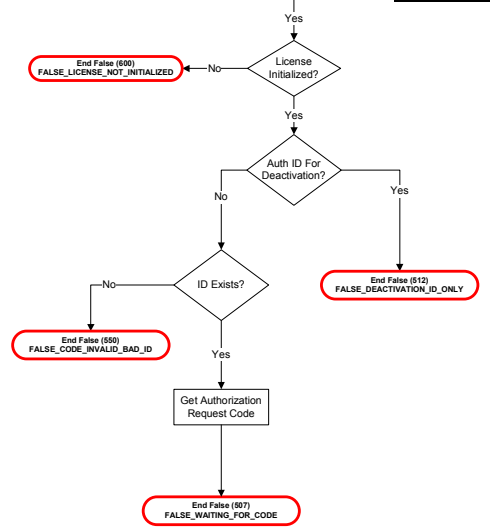

ForceDeactivate()

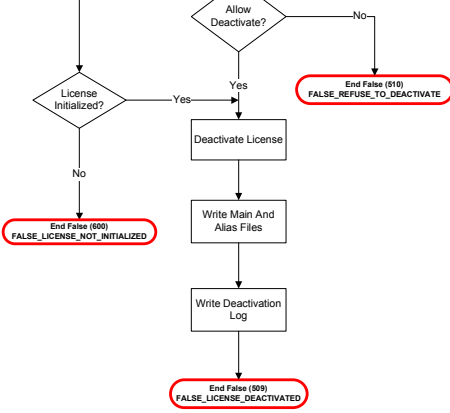

GetAuthorizationDetails() & ...Ex()

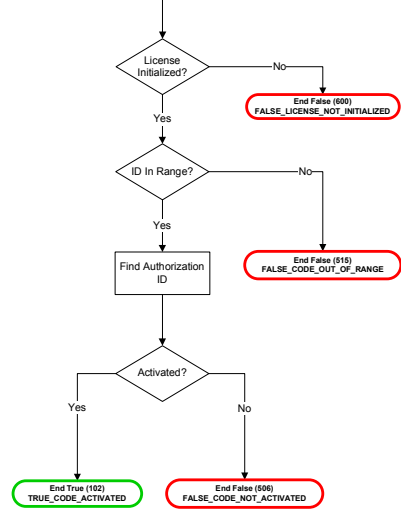

SetAuthorizationDetails() & ...Ex()

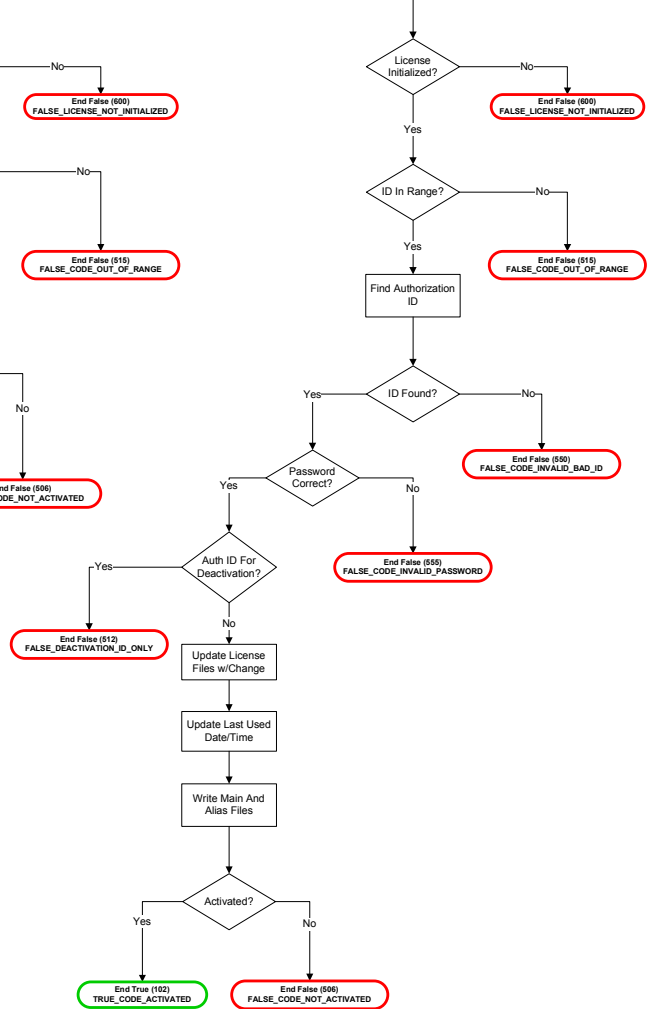

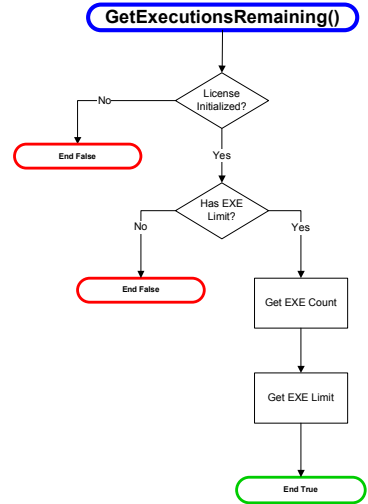
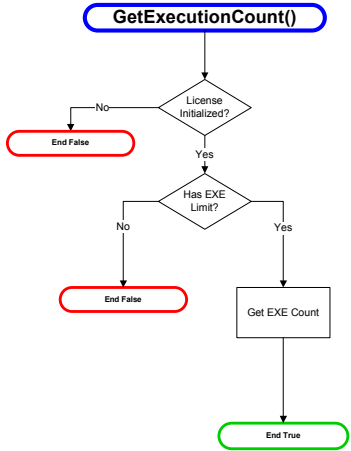
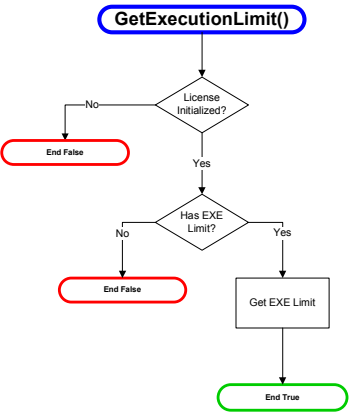
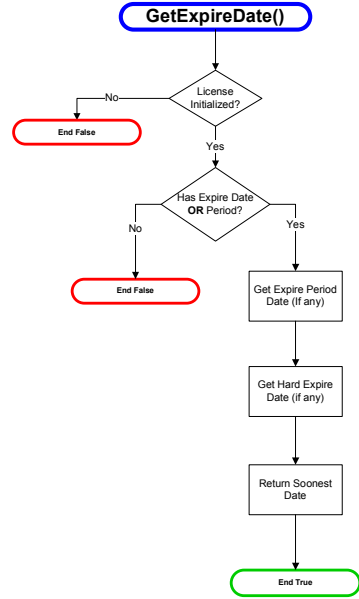
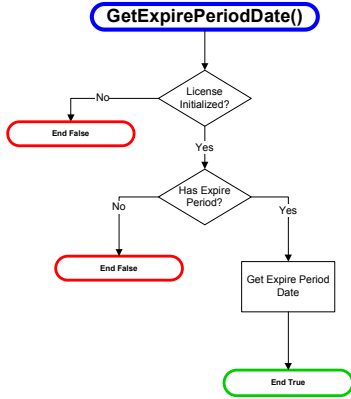
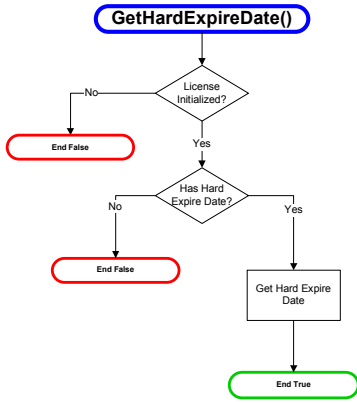

ValidateActivationCode()

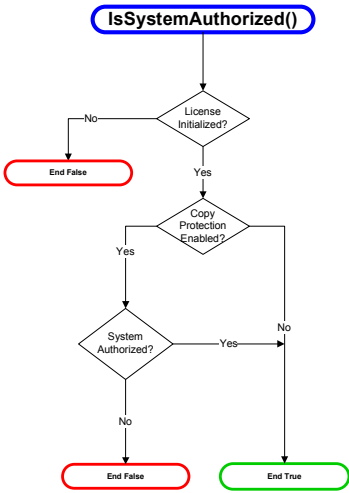
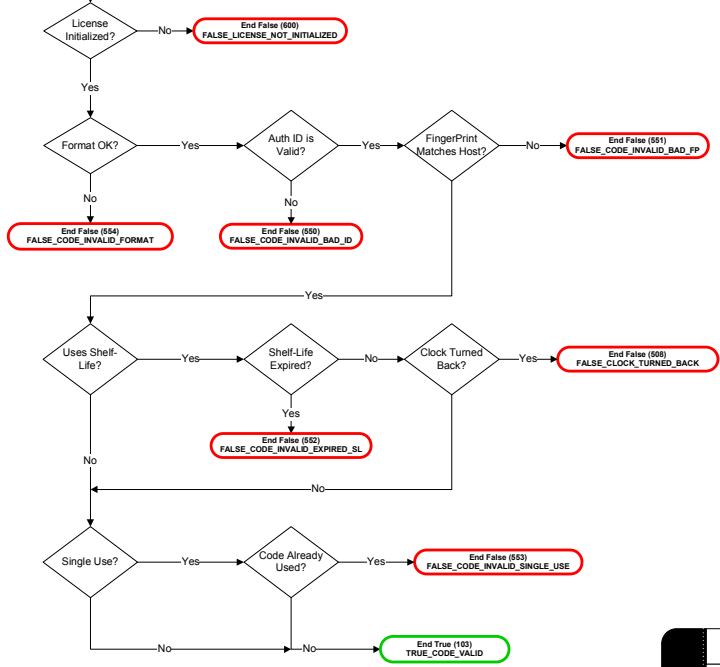

SNCheckInCopyProtection()

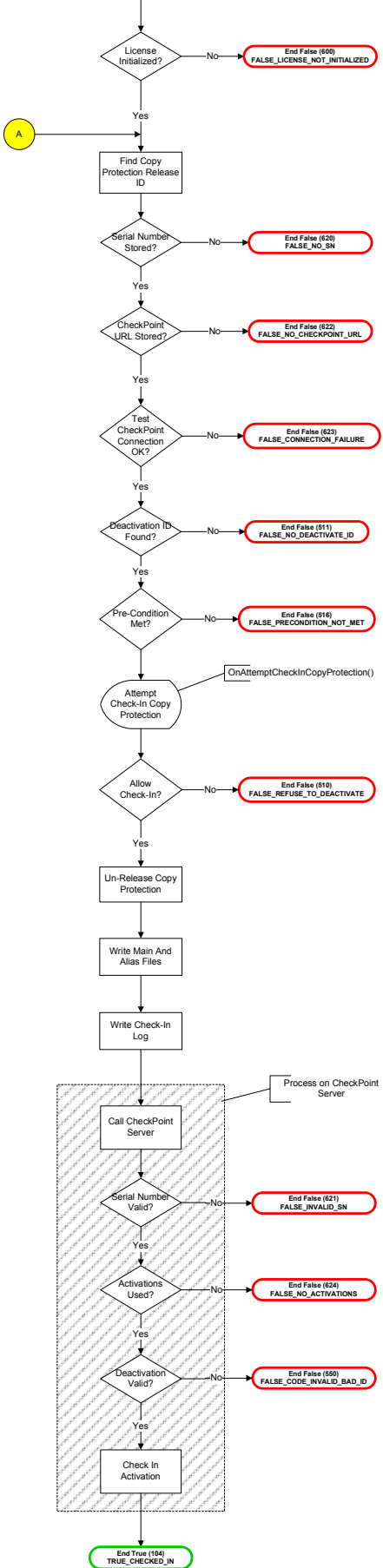

SNCheckInBySN()

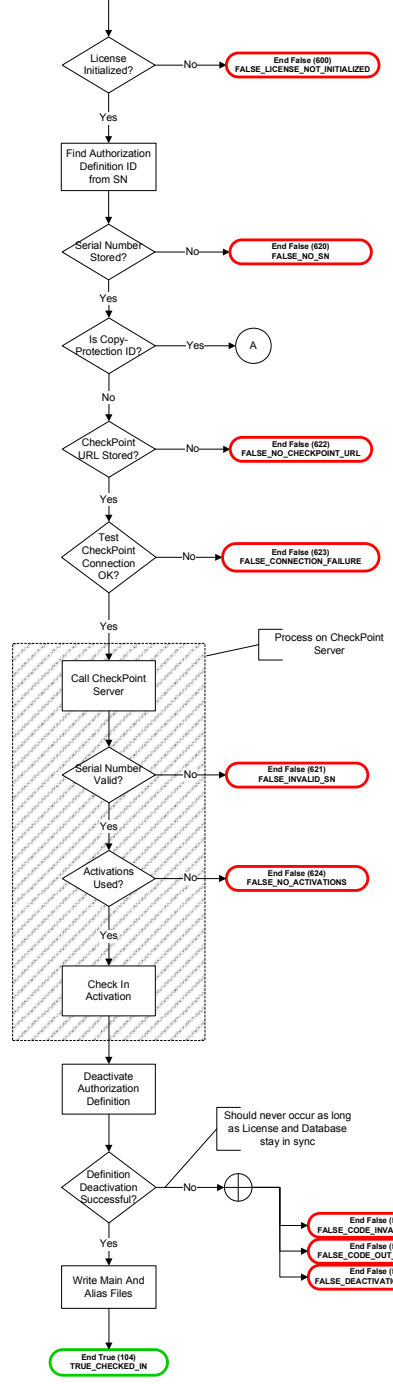

SNCheckInByID()

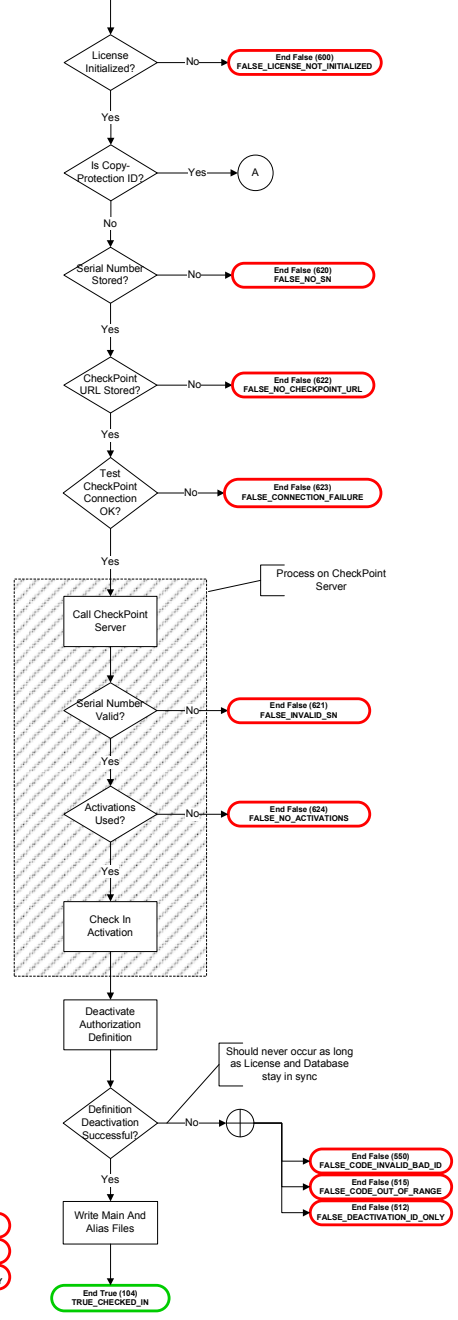

AutoActivateSerialNumber()

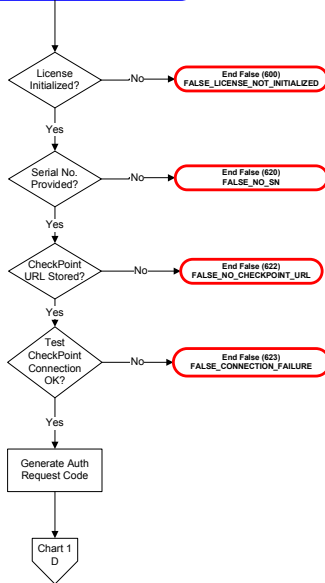

InputActivationCodeSN()

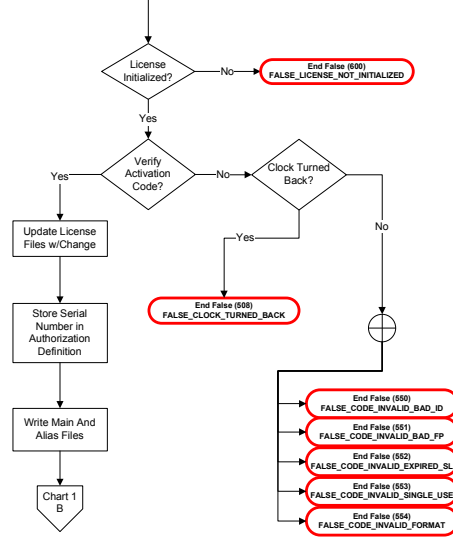

QuickTestCheckPointConnection()

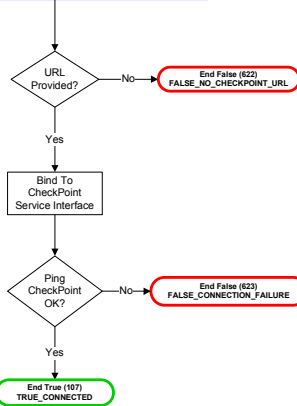

ValidateExpiration()

